



METEOROLOGICAL INSTRUMENTS

INSTRUCTIONS

**ULTRASONIC ANEMOMETER
MODEL 81000**





MODEL 81000 ULTRASONIC ANEMOMETER



1.0 SPECIFICATION SUMMARY

WIND SPEED

Range: 0 to 40 m/s (0 to 90 mph)
 Resolution: 0.01 m/s
 Threshold: 0.01 m/s
 Accuracy: $\pm 1\%$ rms ± 0.05 m/s (0 to 30 m/s)
 $\pm 3\%$ rms (30 to 40 m/s)

WIND DIRECTION

Azimuth Range: 0.0 to 359.9 degrees
 Elevation Range: ± 60.0 degrees
 Resolution: 0.1 degree
 Accuracy: $\pm 2^\circ$ (1 to 30 m/s)
 $\pm 5^\circ$ (30 to 40 m/s)

SPEED OF SOUND

Range: 300 to 360 m/s
 Resolution: 0.01 m/s
 Accuracy: $\pm 0.1\%$ rms ± 0.05 m/s (0 to 30 m/s wind)

SONIC TEMPERATURE

Range: -50 to +50 °C
 Resolution: 0.01 °C
 Accuracy: ± 2 °C (0 to 30 m/s wind)

VOLTAGE OUTPUT (4 CHANNELS)

Range: 0 to 5000 mV
 Resolution: 12 Bit
 Accuracy: $\pm 0.1\%$ of full scale

GENERAL

Air sample column: 10 cm high X 10 cm diameter
 Air sample path: 15 cm
 Output rate: 4 to 32 Hz (selectable)
 Output formats: Serial data (selectable)
 RS-232 and RS-485
 Baud Rates: 1200 to 38400
 Power Supply: 12 to 24 VDC, 110 mA
 Dimensions: Overall height 56 cm
 Support arm radius 17 cm
 Mounting 34 mm (1.34 in) diameter
 (standard 1 inch pipe)
 Weight: Sensor weight 1.7 kg (3.8 lb)

2.0 INTRODUCTION

The Young Model 81000 measures three dimensional wind velocity and speed of sound based on the transit time of ultrasonic acoustic signals. Sonic temperature is derived from speed of sound which is corrected for crosswind effects.

Measurement data are available as serial output using RS-232 or RS-485 connections. A variety of serial output formats are available including a custom format which is easily set by the user. Four voltage output channels representing sonic temperature and wind in either Cartesian or Polar coordinates are also provided.

Operating parameters may be edited via simplified menus using an ordinary serial communication program like HyperTerm. All parameters are stored in non-volatile memory.

Superior environmental resistance is achieved by using UV stabilized thermoplastic, stainless steel, and anodized aluminum components. Electrical connections are made via an easily accessible junction box. The unit mounts on standard 1 inch pipe, outside diameter 34mm (1.34").

3.0 INITIAL CHECKOUT

Carefully unpack the unit and inspect for physical damage. Any damage should be reported to the shipper. The sensor arrives fully calibrated and ready to use.

FACTORY DEFAULT CONFIGURATION:

Serial Output:

- RS232 at 38400 Baud
- ASCII Text Serial String
 - Wind Speed - 3D (m/s)
 - Direction (Deg)
 - Elevation (Deg)
 - Speed of Sound (m/s)
 - Sonic Temperature (°C)

Analog Voltage Outputs:

- Channel V1: Wind Speed (3D)
0-5000 mV = 0-50 m/s
- Channel V2: Wind Direction
0-5000mV = 0-540 Deg
- Channel V3: Elevation
0-5000mV = -60° to +60°
- Channel V4: Sonic Temperature
0-5000mV = 220K to 320K

A simple four-step operational check may be performed as follows:

1. Remove junction box cover. Connect power and signal wires to terminals as indicated in wiring diagram (APPENDIX A) for RS-232 OUTPUT. Connect serial cable to computer COM port.
2. Start a serial communications program (like HyperTerm) with baud rate at 38400 and flow control set to NONE.

3. Apply power to the 81000 sensor. There will be a 4 second delay for initialization then the unit will begin to output data at four times per second using the following format: speed (m/s) azimuth (deg) elevation (deg) speed-of-sound (m/s) sonic-temperature (°C). Verify that all values are present on the display. Typical output is shown below:

```
0.00 0.0 0.0 346.70 25.14
0.00 0.0 0.0 346.68 25.11
0.00 0.0 0.0 346.76 25.25
0.00 0.0 0.0 346.80 25.30
0.00 0.0 0.0 346.76 25.25
0.00 0.0 0.0 346.80 25.30
0.00 0.0 0.0 346.80 25.30
0.00 0.0 0.0 346.82 25.35
```

A threshold level of 0.2 m/s is preset from the factory. Wind below the threshold, such as in still air, is output as 0.00 m/s. Azimuth may be any value from 0.0 to 359.9 degrees. When wind speed is below threshold level, azimuth output is maintained at the last value read before the wind speed went below threshold. Elevation also remains zero until threshold is exceeded. Speed of sound ranges from 300 m/s to 360 m/s depending on temperature. At 20°C the value is about 344 m/s. Sonic temperature may be compared to a standard Celsius thermometer and should agree within ±2°C. If values appear questionable or any value is not displayed, remove power and check all wiring connections. If the problem cannot be corrected, contact your YOUNG representative.

4. Verify sensor response by gently blowing through the measuring section. Wind from the north side (marked "N"), should produce a positive SPEED response and an AZIMUTH display corresponding to North (i.e.: values around 359.9 or 0.0). Wind from the opposite direction should produce values indicating south, (around 180.0) and so forth. Downward wind produces negative ELEVATION values, upward wind produces positive values.

After proper operation is confirmed, the sensor may be installed. Complex data collection or serial communication schemes should be tested and verified before final installation. It is easier to confirm wiring connections and communication protocol on a test bench than a tower. Factory settings may be changed by following the instructions in the next section.

4.0 COMMAND MENU

Sending the ESC character (ASCII 27) three times in quick succession takes the unit out of OPERATE mode and causes the COMMAND MENU to appear.

```
COMMANDS (VERSION 7.0.05)
-----
R) REPORT
S) SETUP
X) EXIT TO OPERATE MODE
```

Access each menu item by sending the character associated with the menu item of interest. Characters may be upper or lower case. Send "X" to return to OPERATE mode. The following paragraphs explain the function of each menu item and associated sub-menu. The version number may differ from that shown above.

NOTE: Command menu access requires standard RS-232 or full-duplex RS-485 non-bussed communication.

5.0 REPORT

REPORT summarizes current parameter settings. Some parameters are for factory diagnostics only and cannot be accessed or altered by the user. Typical values appear as follows:

```
PATH LENGTH(cm) CH DELAY(uS) CMP
-----
A 15.341 1 19.650 516
4 19.550 484
B 15.245 2 23.875 570
5 23.750 524
C 15.146 3 26.675 511
6 26.500 466
```

```
OUTPUT FORMAT: CUSTOM
789AB [ 3D-SPEED AZIMUTH ELEVATION SOS Ts ]
WIND SPEED UNITS: m/s
OUTPUT RATE: 4 Hz
SAMPLES FOR AVERAGE: 0
MODE: AUTO
WAKE CORRECTION: YES
ERROR HANDLING: OMIT INVALID DATA
VOLTAGE OUTPUT FORMAT: SPEED, AZIMUTH, ELEVATION, TEMP
VOLTAGE OUTPUT SCALE: 0 TO 25 m/s = 0-5000 mV
0 TO 540 DEG AZIMUTH = 0-5000mV
-60 TO +60 DEG ELEVATION = 0-5000 mV
220K to 320 K DEG KELVIN = 0-5000mV
CORRELATION TOLERANCE: 125
COMPARE SHIFT: 0
HI SPEED ADC SAMPLES: 10
THRESHOLD: 20 cm/s
ACCESS LEVEL: NORMAL
```

6.0 SETUP

SETUP allows editing operating parameters to suit the needs of a particular application. The SETUP menu and detailed explanation of each menu item follows:

```
SET PARAMETERS
-----
A) AVERAGING
B) BAUD
E) ERROR HANDLING
N) SCALING MULT
O) OUTPUT RATE
P) POLL CHARACTER (ADDR)
S) SER OUT FORMAT
T) THRESHOLD
U) UNITS
V) V OUT FORMAT
W) WAKE CORRECTION
X) EXIT TO MAIN MENU
```

6.1 AVERAGING

AVERAGING sets the number of output samples used to calculate block averages of wind measurements. With NUMBER OF SAMPLES TO AVERAGE set to 0, no averaging takes place.

The block average update rate is a function of OUTPUT RATE and NUMBER OF SAMPLES TO AVERAGE.

$$\text{Update Rate (Hz)} = (\text{OUTPUT RATE})/(\text{SAMPLES TO AVG})$$

```
NUMBER OF SAMPLES TO AVERAGE: 0
ENTER NEW VALUE (0 - 320):
```

6.2 BAUD RATE

BAUD sets the baud rate for serial communication. Faster baud rates may be required if the output string is long and the output rate is fast (see OUTPUT RATE). There is also a setting for HALF or FULL duplex RS-485. HALF duplex may be used in simple installations where minimal wiring is required and the unit is set for continuous output. Use FULL duplex when polling or frequent parameter changes are anticipated. Note that the DUPLEX setting applies to RS-485 only since the RS-232 is always full duplex by default.

```

BAUD: 38400
-----
A) 1200
B) 2400
C) 4800
D) 9600
E) 19200
F) 38400
X) EXIT TO MAIN MENU

FOR RS-485 ONLY!
DUPLX = 2
-----
1) HALF
2) FULL
X) EXIT TO MAIN MENU

```

6.3 ERROR HANDLING

ERROR HANDLING determines the manner in which invalid measurements are handled. Invalid measurements can occur when the acoustic path of the sonic signal is blocked or internal circuits fail. Acoustic blockage may be caused by rain drops, ice, snow, or other debris on the transducers. When set to INCLUDE INVALID DATA, an output always occurs. If CUSTOM serial output is used, an ERROR CODE may be included in the output string to indicate an error condition. When set to OMIT INVALID DATA, invalid measurements are not output.

```

ERROR HANDLING: 2
-----
1) INCLUDE INVALID DATA
2) OMIT INVALID DATA
X) EXIT

```

6.4 SCALING MULTIPLIER

SCALING MULT sets overall scaling for UVW, 2D, and 3D wind speed outputs. Azimuth and elevation angle are not effected. The default value of 10000 represents a scaling multiplier of 1.0000. Normally, this value should not be changed since each instrument is calibrated in the YOUNG factory wind tunnel. Users who wish to alter the scaling based on independent calibration assessment may use this parameter to do so.

```

SCALING MULTIPLIER: 10000
ENTER NEW VALUE:

```

6.5 OUTPUT RATE

OUTPUT RATE sets the rate at which samples serially output. Fast output rates and long serial output strings may require higher baud rates in order to keep up with the outgoing data stream. See SERIAL COMMUNICATION in SECTION 7 for additional details. If AVERAGING is used, average results are available only after enough output samples have been collected. See AVERAGING for details.

```

OUTPUT RATE 4Hz
-----
A) 4 HZ
B) 5 HZ
C) 8 HZ
D) 10 HZ
E) 16 HZ
F) 20 HZ
G) 32 HZ
X) EXIT TO MAIN MENU

```

6.6 POLL CHARACTER

POLL CHARACTER (ADDR) sets the address character for polled operation (POLL CUSTOM or POLLED BINARY output formats). Any printable ASCII character may be used to assign an address that uniquely identifies the instrument. When bussed on an RS-485

network with other 81000 instruments, each one should have a different address character.

```

POLL CHARACTER (ADDR): A
ENTER NEW CHARACTER:

```

To poll the 81000, send MA! where A is the unique POLL CHARACTER. The 81000 will respond with the POLL CHARACTER and a space followed by the serial output string.

6.7 SERIAL OUTPUT FORMAT

SERIAL OUTPUT FORMAT sets the output string for serial output. Preset and custom formats are available.

```

SERIAL OUTPUT FORMAT 1
-----
1) CUSTOM
3) NMEA (CHANGES OTHER PARAMETERS, SEE MANUAL)
4) POLLED CUSTOM
6) POLLED BINARY
X) EXIT TO MAIN MENU

```

CUSTOM

CUSTOM format allows the user to construct an ASCII-printable serial output string. Long strings may require higher BAUD rates or lower OUTPUT RATES. (See BAUD and OUTPUT RATE.) Also, see UNITS. When CUSTOM is selected the following message and sub-menu appear:

```

CURRENT SERIAL OUTPUT FORMAT:
789AB [ 3D-SPEED AZIMUTH ELEVATION SOS Ts ]
CONSTRUCT AN OUTPUT FORMAT BY SELECTING FROM THE LIST BELOW.
ELEMENTS MAY BE IN ANY ORDER. REFER TO MANUAL FOR DETAILS.
-----
5) UVW
6) 2D SPEED
7) 3D SPEED
8) AZIMUTH
9) ELEVATION
A) SOS
B) Ts
C) CHKSUM
E) ERR CODE
V) INTERNAL VOLTAGE

ENTER CUSTOM STRING (12 CHARACTERS MAX):

```

UVW is the orthogonal u, v, and w wind velocities. All three values are output. Typically the 81000 is oriented with u-axis aligned east-west and v-axis aligned north-south. In this orientation, +u values = wind from the east; +v values = wind from the north. Wind from below (updraft) = +w. Refer to Appendix B for illustration.

2D SPEED is wind magnitude in the u-v plane.

3D SPEED is wind magnitude in three dimensional space.

AZIMUTH is the 0.0-359.9° wind direction angle in the u-v plane. With the 81000V junction box facing south, 0.0° = north, 90.0° = east, 180.0° = south, and 270.0° = west. Refer to Appendix B for illustration.

ELEVATION is the ±90.0° wind elevation angle relative to the u-v plane. Values are positive when wind is from below (updraft) and negative when from above (downdraft). Effective elevation angle measurements are limited to ±60.0°. Refer to Appendix B for illustration.

SOS is the speed of sound.

Ts is the sonic temperature derived from SOS.

CHKSUM calculates the bitwise exclusive-or of all characters in the output string starting with the first character and ending with the last character of the last field before the checksum. The checksum is expressed as a two-digit hex value preceded a space.

ERROR CODE indicates the validity of the measurement. Any non-zero value indicates an invalid measurement. ERROR HANDLING must be set to INCLUDE INVALID DATA to use this field. Keys to the error codes provide no useful information to the user.

INTERNAL VOLTAGE is the internal supply voltage. Because it is measured after current overload protection devices, it will always be less than the supply voltage measured at the connection terminals.

NMEA

NMEA sends wind speed and direction in NMEA marine format to Young Model 06206 Marine Wind Tracker display or other NMEA device. The sentence is \$WIMWV,aaa,R,ss.s,N,A where aaa = wind direction angle in degrees and ss.s = wind speed in knots.

When NMEA is selected the OUTPUT RATE is changed to 4 Hz and THRESHOLD is set to 50 cm/sec. Most NMEA systems use 4800 baud but, because some systems use other baud rates, this setting should be changed manually if necessary.

POLLED CUSTOM

POLL CUSTOM format allows the sensor to be polled for a measurement. See CUSTOM for details on constructing the output string. Poll by sending MA! (where 'A' is the POLL CHARACTER ADDRESS).

After a measurement has completed, the sensor responds with the POLL CHARACTER followed by the custom serial output string.

Up to 32 sonic anemometers may be networked using the RS-485 connection. By assigning a unique address to each device, multiple units may run on the same network and respond individually only when polled.

POLLED BINARY

POLLED BINARY starts a measurement and sends serial data in binary rather than ASCII format. The advantage of using POLLED BINARY output format is that data output strings are shorter and data does not have to be parsed and converted from ASCII characters to numeric values. The disadvantage is that the output cannot be examined directly as text. The 10-byte binary output string description appears below.

Byte Index	Description
0	U vector cm/s (signed 2-byte integer)
2	V vector cm/s (signed 2-byte integer)
4	W vector cm/s (signed 2-byte integer)
6	T Sonic temperature K x 100 (unsigned 2-byte integer)
8	Status (byte non-zero = error)
9	Checksum (byte, XOR of all char, hex val)

The POLLED BINARY format may be employed using one of two different methods.

The first method uses the **MA!** command to initiate a sonic measurement ('A' is the sensor POLL CHARACTER ADDRESS, see section 6.6). When the measurement is complete, the sensor automatically transmits measurement data in binary form. The delay between the start of the measurement and data availability is

determined by the OUTPUT RATE parameter (see section 6.5)

The second method uses separate trigger and data-retrieval commands. Any sensor that receives a **Tr!** command while set for POLLED BINARY operation will immediately start a sonic measurement. The command is not address-specific. When the measurement is complete, data will be available for retrieval using the **RA!** command ('A' is the unique POLL CHARACTER ADDRESS, see section 6.6).

The time required to complete a measurement after the **Tr!** command depends on OUTPUT RATE. Also, if multiple sensors are connected on a shared RS-485 bus, each **RA!** command and its reply must be given enough time to complete. The time constraints are shown in the table below:

Output Rate (Hz)	Measurement Complete (ms)	Minimum Delay between bussed RA! cmds (ms)
4	225	33
5	175	23
8	115	13
10	90	11
16	58	8
20	45	8
32	25	8

The **Tr!/RA!** trigger/retrieve method is useful for synchronizing simultaneous measurements with multiple 81000 sensors. After completing a measurement triggered by the **Tr!** command, data from each sensor (uniquely addressed) can be retrieved with the **RA!** command. Data rates up to 10 Hz with six sensors on a single full-duplex bus have been demonstrated (38.4k baud). Faster rates or more sensors may be configured by adjusting operating parameters.

6.8 THRESHOLD

THRESHOLD sets wind speed threshold for the following output formats only: NMEA, SPEED AZIMUTH ELEVATION. UVW outputs are unaffected. Setting THRESHOLD greater than 0 prevents fluctuating azimuth and elevation values at wind speeds near zero. While these values are correctly derived, they are meaningless or distracting in some applications.

When wind speed is at or above threshold, all output values are updated normally. When speed is below threshold, speed and elevation outputs are set to zero and the azimuth output is held at its last value. Setting THRESHOLD to 0 effectively disables the feature. Note that units are cm/sec.

```
THRESHOLD (cm/s) : 20
ENTER NEW THRESHOLD (cm/s, 0-500) :
```

6.9 UNITS

UNITS sets wind speed units for CUSTOM serial output. Resolution associated temperature units are as follows:

Wind Speed units and resolution	Temperature units and resolution
cm/s 1	K 0.01

m/s	0.01	C°	0.01
mph	0.1	F°	0.01
km/h	0.1	C°	0.01
knots	0.1	F°	0.01

```

UNITS 2
-----
1) cm/s
2) m/s
3) mph
4) km/h
5) knots
X) EXIT TO MAIN MENU

```

6.10 VOLTAGE OUTPUT FORMAT

VOLTAGE OUTPUT FORMAT sets format, scaling and output range for voltage outputs. Only wind speed scaling may be set by the user. AZIMUTH, ELEVATION, and SONIC TEMPERATURE scaling is fixed. Full scale output range for all voltage outputs may be set to either 0-4000 or 0-5000 millivolts.

Choose format from the menu.

```

VOLTAGE OUTPUT FORMAT 2
-----
1)   U V W TEMP
2)   SPEED AZ ELEV TEMP
X)   EXIT

```

6.10.1 SCALING

If UVW format is chosen, the following prompt is shown with current wind scale setting:

```

VOLTAGE OUTPUT SCALE: -25 TO 25 m/s
ENTER NEW VALUE (10-60):

```

You must enter a value for the scale. Note that with UVW format, the value you enter will be bipolar scale (ie: 25 means -25 to +25 m/s).

If SPEED AZIMUTH ELEVATION format is selected, the following prompt is shown with current wind scale setting:

```

VOLTAGE OUTPUT SCALE: 0 TO 50 m/s
ENTER NEW VALUE (10-60):

```

You must enter a value for the scale.

With SPEED AZIMUTH ELEVATION format, AZIMUTH scale is fixed at 0 to 540° and ELEVATION is fixed at -60° to +60°.

SONIC TEMPERATURE scale is always 220 °K to 320°K.

6.10.2 RANGE

After setting the scale, the current setting for output range is shown along with a menu for changing it.

```

VOLTAGE OUTPUT FULL SCALE = 5
-----
4) 4000 mV
5) 5000 mV
X) EXIT

```

The 5000 millivolt (mV) output range (default) is recommended for all new installations. The 4000 mV range is compatible with earlier models.

6.10.3 CONVERSION TO ENGINEERING UNITS

The range applies to all voltage output channels. The following relationships may be used to interpret output values:

For UVW format:

U,V, or W windspeed = [(Scale x 2 / Range) x mV] - Scale

Example:

W channel output value = 2550 mV
Scale = 25 m/s
Range = 5000 mV
SPEED = [(25 x 2 / 5000) x 2550] - 25 = 0.5 m/s

For SPEED AZIMUTH ELEVATION Format:

Windspeed = [(Scale / Range) x mV]

Example:

SPEED channel output value = 1950 mV

Scale = 25 m/s

Range = 5000 mV

Speed = [(25 / 5000) x 1950] = 9.75 m/s

Azimuth = [(540 / Range) x mV]

Example:

AZIMUTH channel output value = 4250 mV

Range = 5000 mV

Azimuth = [(540 / 5000) x 4250] = 459°

If the result is greater than 360, subtract 360.

Azimuth = (459 - 360) = 99°

Elevation Angle = [(120 / Range) x mV] - 60

Example:

ELEVATION channel output value = 2200 mV

Range = 5000 mV

Elevation Angle = [(120 / 5000) x 2200] - 60 = -7.2°

Voltage output scale for sonic temperature depends only on the temperature voltage output value and selected range.

Temperature = [(100 / Range) x mV] + 220

Example:

TEMPERATURE channel output value = 3780 mV

Range = 5000 mV

Temp °K = [(100 / 5000) x 3780] + 220 = 295.6 °K

To convert to °C, subtract 273.15.

295.6 - 273.15 = 22.45 °C

When ERROR HANDLING is set to INCLUDE INVALID DATA, the voltage output channels go to positive full scale when an invalid measurement occurs. When set to OMIT INVALID DATA, the voltage output remains at the last valid value until a new valid measurement occurs.

IMPORTANT:

For VOLTAGE OUTPUTS to function properly, the 81000 serial output must be set to CUSTOM format.

6.11 WAKE CORRECTIONS

WAKE CORRECTION enables or disables real-time correction algorithms. To compensate for flow distortions in the wake of support struts and other mechanical features, each 81000 is individually calibrated in the YOUNG factory wind tunnel (NIST traceable) to generate a unique correction table which is stored in the unit. Additional compensating algorithms correct for elevation angle distortions and crosswind effects on speed of sound.

```

WAKE CORRECTION: YES
USE WAKE CORRECTION? (Y/N):

```

7.0 APPLICATION NOTES

SERIAL COMMUNICATION

Selection of RS232 or RS485 is made inside the sensor j-box by positioning the shorting blocks on jumper W6. Typical wiring connections are shown in APPENDIX A. RS-485 half-duplex connections can simplify some installations since less cable is

needed and, when operated in polled mode, the connections may be bussed.

Long custom output strings at high output rates and low baud rates may exceed the time needed to send the string. Solutions include using fewer measurement parameters, lower OUTPUT RATES, higher BAUD RATE, or some combination of these solutions. With measurement parameters, for example, sending wind data in both UVW and SPEED, AZIMUTH, ELEVATION formats is redundant and wastes space in the string.

HALF DUPLEX TIMING CONSTRAINTS

If RS-485 half-duplex mode is used for continuous output, high output rates and long output strings create a progressively smaller window of time in which to receive commands. Under some conditions, the 81000 may not respond to the ESC commands since the unit will be spending most of its time in transmit mode. RS-485 is best used in POLLED MODE or at modest output rates. In contrast, a full-duplex RS-232 or RS-485 scheme is immune to the timing limitations described above and commands may be received even while data is being sent.

Polling in half-duplex RS-485 mode at high rates may be limited by the timing capability of both the polling device and the 81000. Advantages gained from bussing multiple sensors may be lost if timing problems arise. For fast polling, a full-duplex scheme is recommended.

HIGH WIND SPEED MEASUREMENTS

For best measurement results, particularly at high wind speeds, always choose the lowest OUTPUT RATE possible. Lower output rates use a greater number of internal samples to generate the result and are more immune to outliers in the samples. If measuring for spectral content, carefully determine the needed sampling rate and use the lowest OUTPUT RATE necessary.

RAIN AND SNOW

Anything that blocks the acoustic signal path will degrade the measurement. If the path is blocked sufficiently, measurements cannot be made. The 81000 can make accurate measurements in driving rain even at high OUTPUT RATES but light mist or heavy fog can allow droplets to accumulate on the transducer faces and block the measurement.

Measurements may be made in driving snow although frost and snow that adheres to the transducer face may block the measurement. Similarly, freezing rain on the transducer face may block the measurement.

POWER CONNECTIONS

Supply power must be in the range of 12 to 24 VDC **at the sensor junction box terminals** in order for the sensor to operate properly. For long cables, be sure to allow for voltage drop due to wire resistance.

8.0 WARRANTY

This product is warranted to be free of defects in materials and construction for a period of 12 months from date of initial purchase. Liability is limited to repair or replacement of defective item. A copy of the warranty policy may be obtained from R. M. Young Company.

9.0 CE COMPLIANCE

This product has been tested and shown to comply with European CE requirements for the EMC Directive. Note that shielded cable must be used.

Declaration of Conformity

R. M. Young Company
2801 Aero Park Drive
Traverse City, MI 49686 USA

Model 81000 Ultrasonic Anemometer

The undersigned hereby declares, on behalf of R. M. Young Company that the above-referenced product, to which this declaration relates, is in conformity with the provisions of:

Council Directive 2004/108/EC (December 15, 2004)
on Electromagnetic Compatibility



David Poinsett
R&D Manager

APPENDIX A: WIRING CONNECTIONS

RS-232 Connections

Factory default settings:

- 38400 baud, 1 start, 8 data, no parity, 1 stop bit, no flow control
- 789AB Custom ASCII Serial Output Format
- 7 = 3D Wind Speed (m/s)
- 8 = Wind Direction Angle (0-360°)
- 9 = Wind Elevation Angle (-60 to +60°)
- A = Speed of Sound (m/s)
- B = Sonic Temperature (C°)
- Output Rate 4Hz
- Threshold 20 cm/s (0.2 m/s)
- Wake Correction Enabled
- Omit Invalid Data

See manual section 6.7 for SERIAL OUTPUT FORMAT options.

Verify shorting block jumpers at W5 and W6 as shown.

Use shielded cable. Connect cable shield to ground at one end only as shown. For maximum reliability, connect sensor Earth Ground as close to sensor as possible.

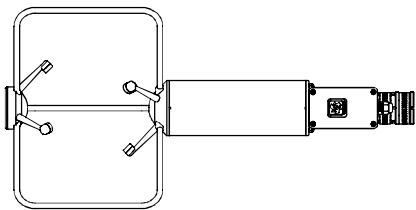

Model 81000
Ultrasonic Anemometer

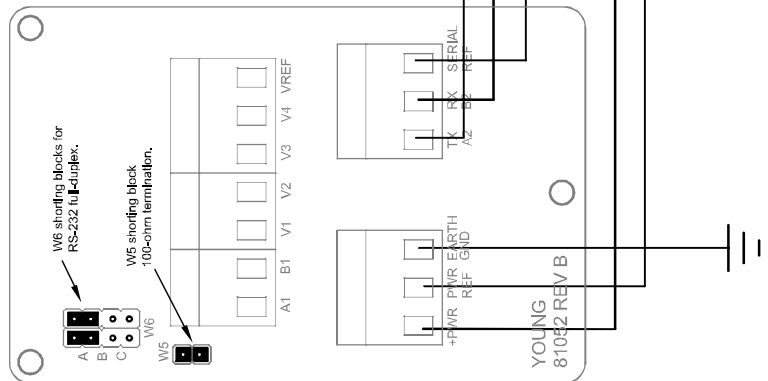

Typical DB-9
RS-232 Connection

(+) Sensor power
(-) 12-24 VDC 110mA max

APPENDIX A: WIRING CONNECTIONS

VOLTAGE OUTPUT CONNECTIONS

Factory default settings:

- V1 3D Wind Speed 0 to 5000 mV = 0 to 50 m/s
- V2 Wind Direction Angle 0 to 5000 mV = 0 to 540°
- V3 Elevation Angle 0 to 5000 mV = -60 to +60°
- V4 Sonic Temperature 0 to 5000 mV = 220K to 320K

Output Rate 4Hz
 Threshold 20 cm/s (0.2 m/s)
 Wake Correction Enabled
 Omit Invalid Data

See manual section 6.10 for VOLTAGE OUTPUT options. For best accuracy, the external voltage measuring device should use a differential connection rather than single ended.

Use shielded cable. Connect cable shield to ground at one end only as shown. For maximum reliability, connect sensor Earth Ground as close to sensor as possible.

Young Model 26700, data logger, or other voltage measuring device

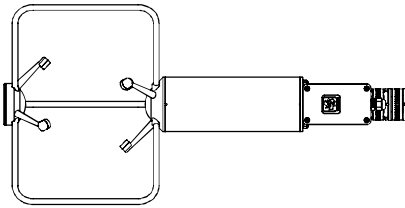

Model 81000
Ultrasonic Anemometer

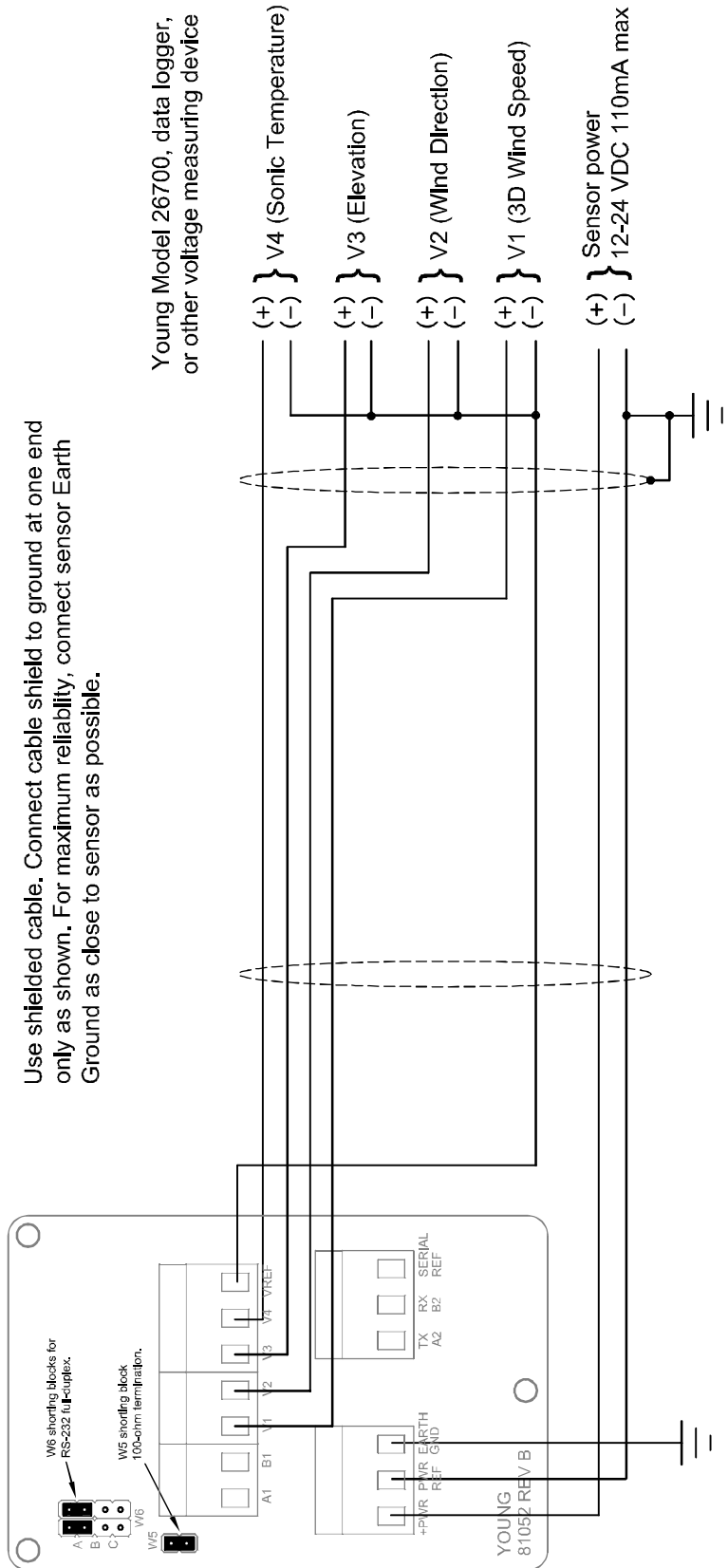

APPENDIX A: WIRING CONNECTIONS

RS-485 Connections

Set BAUD RATE then select option for RS-485 FULL DUPLEX. Use any SERIAL OUTPUT FORMAT (see manual section 6.7). Other parameters settings may apply.

1 start, 8 data, no parity, 1 stop bit, no flow control

Verify shorting block jumpers at W5 and W6 as shown in drawing. If RS-485 connections are bussed, install W5 shorting block in last sensor on bus only.

Use shielded cable. Connect cable shield to ground at one end only as shown. For maximum reliability, connect sensor Earth Ground as close to sensor as possible.

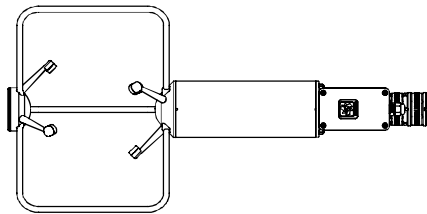

Model 81000

Ultrasonic Anemometer

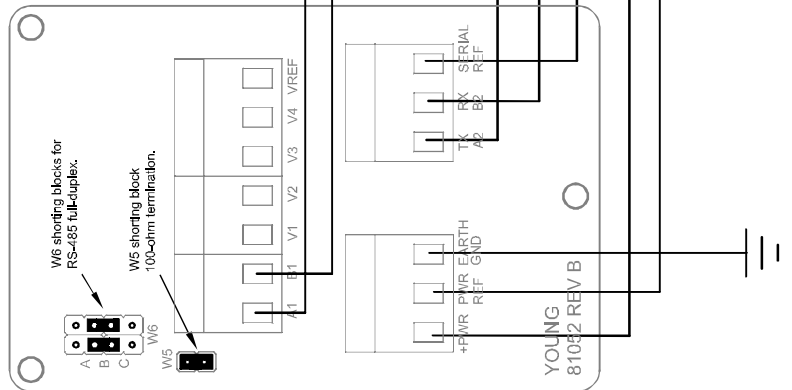

APPENDIX B: SENSOR ORIENTATION AND DIMENSIONS

MODEL 81000 ULTRASONIC ANEMOMETER

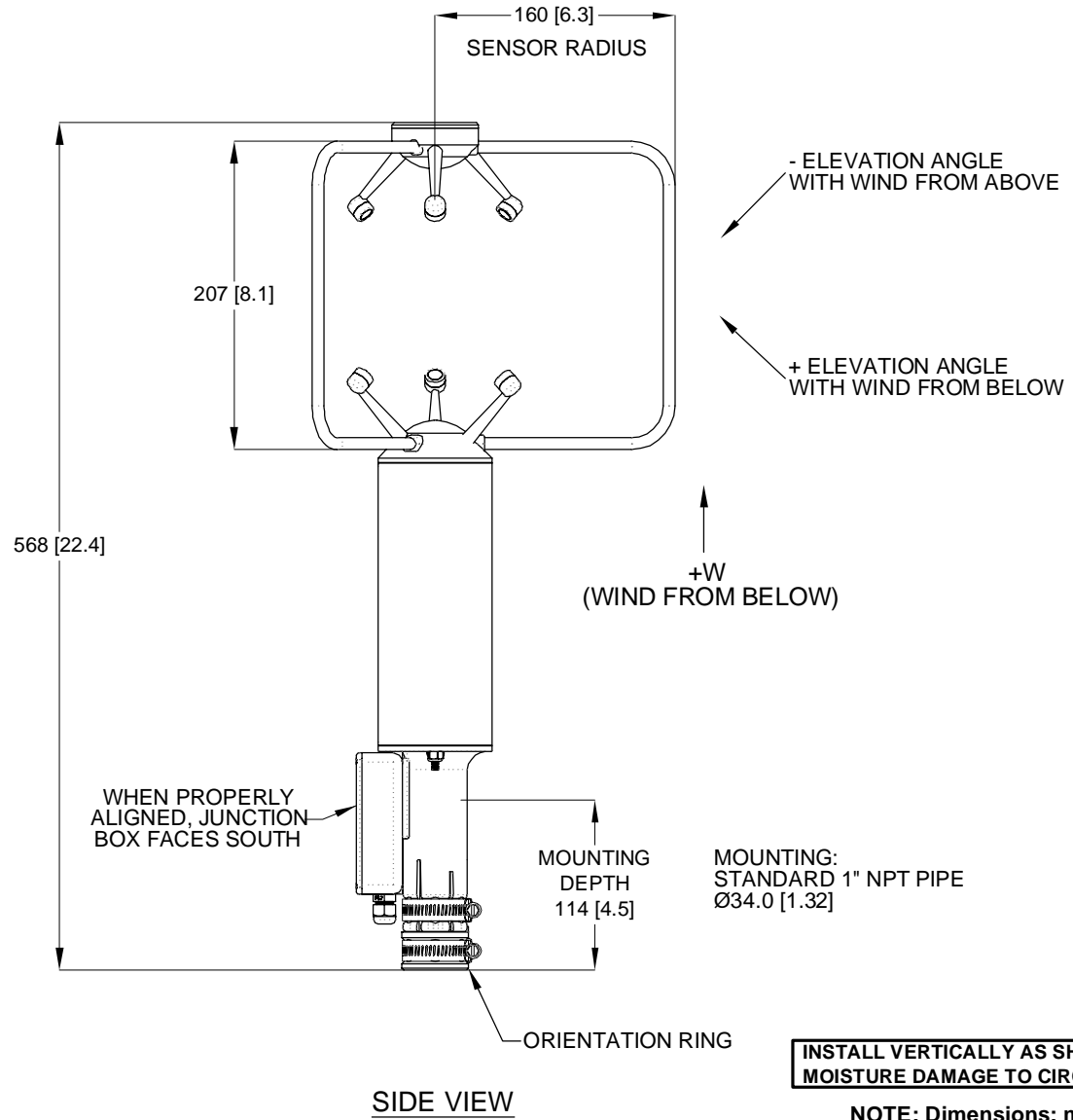
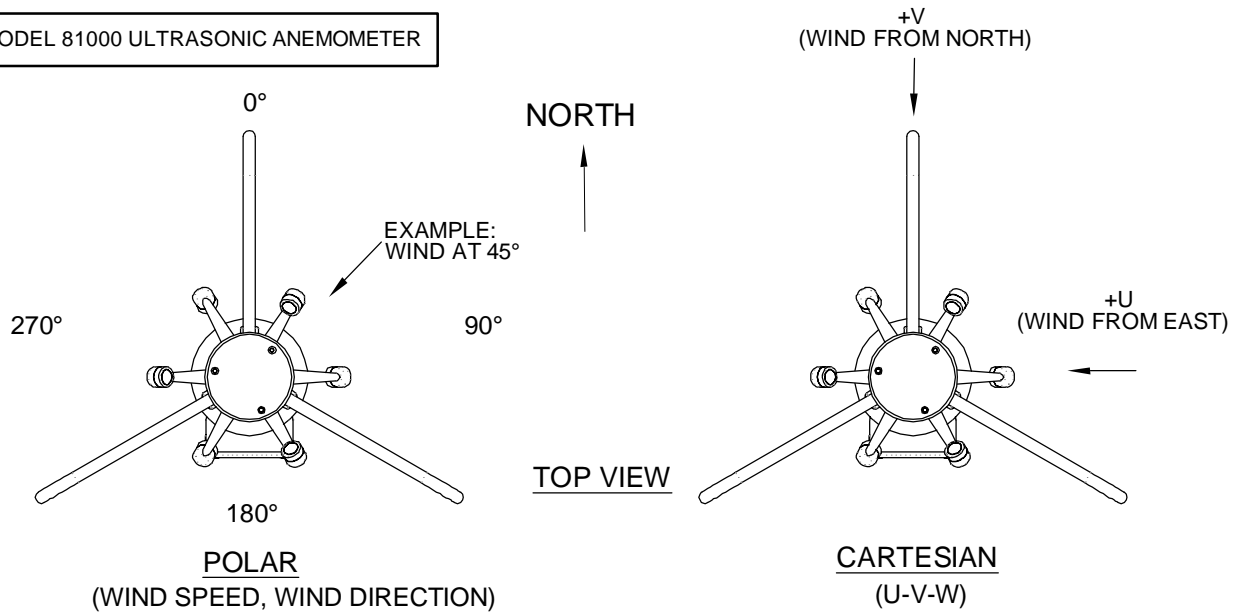

INSTALL VERTICALLY AS SHOWN TO AVOID MOISTURE DAMAGE TO CIRCUITRY.

NOTE: Dimensions: mm [in]